



AVEVA

PRODUCT DATASHEET

Mobile Operator Rounds

Accelerate Maintenance Operations and Improve Regulatory Compliance

Mobile operator rounds enable manufacturers and processors to achieve reliable, safe and profitable operations through consistent execution of best practices by the field workforce — accelerating and sustaining mainstream process improvements and improving regulatory compliance.

Summary

- Enables a culture focused on field operational excellence
- Helps steward the consistent execution of best practices
- Facilitates a communication path between stranded assets and cloud resources like predictive analytics and machine learning
- Supports rapid response to changing business conditions
- Key success factor for equipment reliability
- Helps assimilate new field workers with training materials delivered to handheld mobile devices
- Underlies compliance, health and safety program requirements to facilitate improved regulatory compliance

The Industry-leading Mobile Workforce and Decision Support System

Mobile Operator Rounds accelerates and sustains operational process improvements and is a key component of an effective Operations Management System. Helping ensure that best operating and regulatory procedures are followed at all times, data is collected on non-instrumented plant assets, critical environmental, health and safety inspections are performed on schedule and mobile operators have the information at their fingertips to operate plant assets in the most effective manner possible.

Helping Your Front Line Manage Your Bottom Line

Operational Excellence starts with operators. Mobile Operator Rounds brings the field operator into the automation loop by utilizing a combination of workforce management software, mobile handheld computers, monitoring devices and Radio Frequency Identification (RFID) equipment tags or bar codes. This mobile framework results in a significantly improved decision support system for managing plant assets.

Workers are easily guided through a question and answer process which helps uncover hidden bottlenecks and process or equipment problems. If problems are found, workers are immediately guided, through additional steps or actions to properly identify and address the developing issue.

Exception-based web reports keep everyone on the team up-to-speed on the current state of plant operations.

A Software Development Kit (SDK) ensures the lowest total cost of ownership by adding a highly extensible mobile framework.

Enforce Best Operating Procedures

Best practices are only meaningful if they are consistently and broadly applied across an enterprise. Mobile Operator Rounds presents maintenance tasks to mobile workers and each step can be tracked to ensure compliance and accountability.

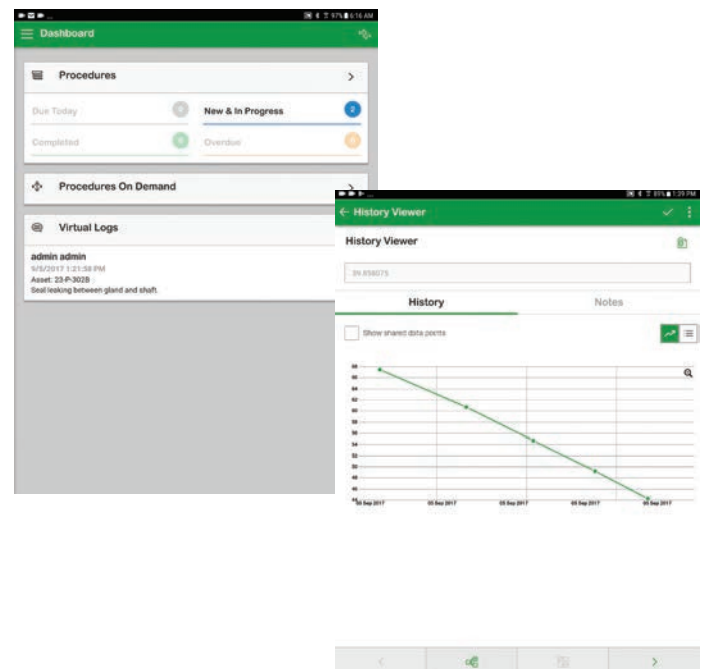

Strategy for Stranded Assets

Stranded or non-instrumented assets often represent 40 to 60% of your asset base but are too often “invisible” to management. Mobile Operator Rounds provides a cost effective strategy for monitoring and reporting back on the performance of stranded assets.

Respond Faster And Improve Your Competitiveness

For the first time, you can execute pre-defined strategies when your business or environmental conditions change, allowing you to improve your organizational agility and competitiveness. Dynamic Procedures allow pre-configured procedures to be

automatically passed to your field operators so they can begin securing a facility or ramping up production on a moment’s notice. Teams know exactly what to do and when. Lag time and confusion are minimized.

As conditions change, the highly extensible and open mobile framework can also deliver mobile procedures directly from a wide range of plant systems. The mobile worker then executes these specific tasks and forwards any collected data information back to the host system. Legacy plant systems never designed with a mobile capability, such as historians, LIMS systems, MES systems and CMMS/EAM systems can now incorporate mobile task execution and field data collection.



“Using Mobile Operator Rounds software has made a major contribution to reaching a plant availability factor above 90%, since it has integrated perfectly with the other innovations added to our equipment.”

- Mauro Tassistro, Applications Team Leader, Infineum

It’s all about Return on Investment!

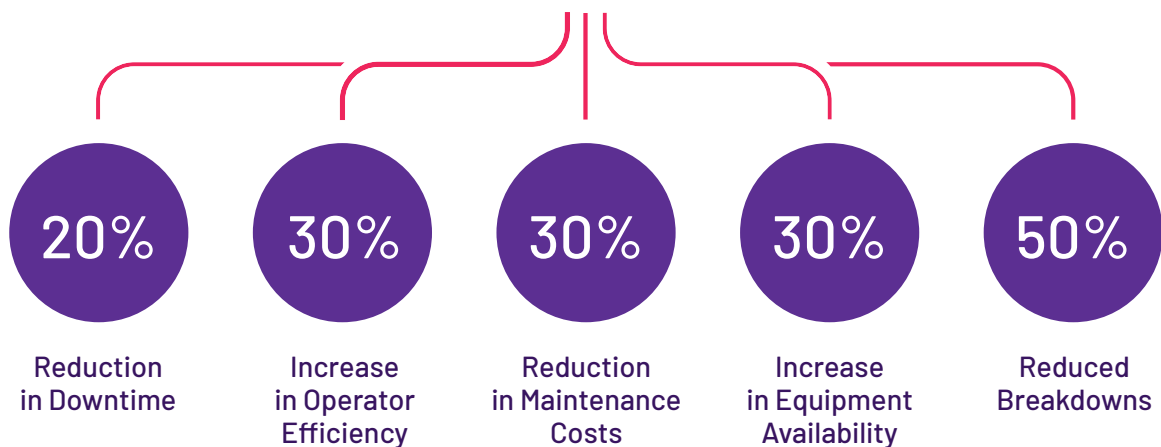

Achieve Greater Process Reliability and Asset Effectiveness

Empowering field workers to be part of the reliability solutions helps drive collective behavior and a culture of asset ownership between operations and maintenance. Equipment condition data such as vibration or temperature can be easily collected by field operators using a mobile solution as they do their regular operating rounds. Stranded or non-instrumented plant assets can now be efficiently monitored.

The asset-centric approach allows data collected by any operator or plant worker to be aggregated together for a common asset history. This means a more complete and comprehensive view of asset performance and health.

Better Management of Workforce Turnover

The innovative on-the-job training approach gets your newest field workers up to speed—FAST. Experienced workers can incorporate their knowledge into operating and inspection rounds. This means best practices can be easily documented and used by all field workers, even the most junior of operators—insulating plants or facilities from a sudden loss of operating knowledge.

Unifying Your Field Workforce with Your Plant Automation System

Now the state-of-the-art System Platform can share data with your mobile workforce. The myriad of plant automation data can now be funneled to your mobile workers keeping them up-to-date on current operational conditions. You can also push field collected data back up into the automation system so it can be exposed in operator displays or to engineers or managers utilizing plant information portals.

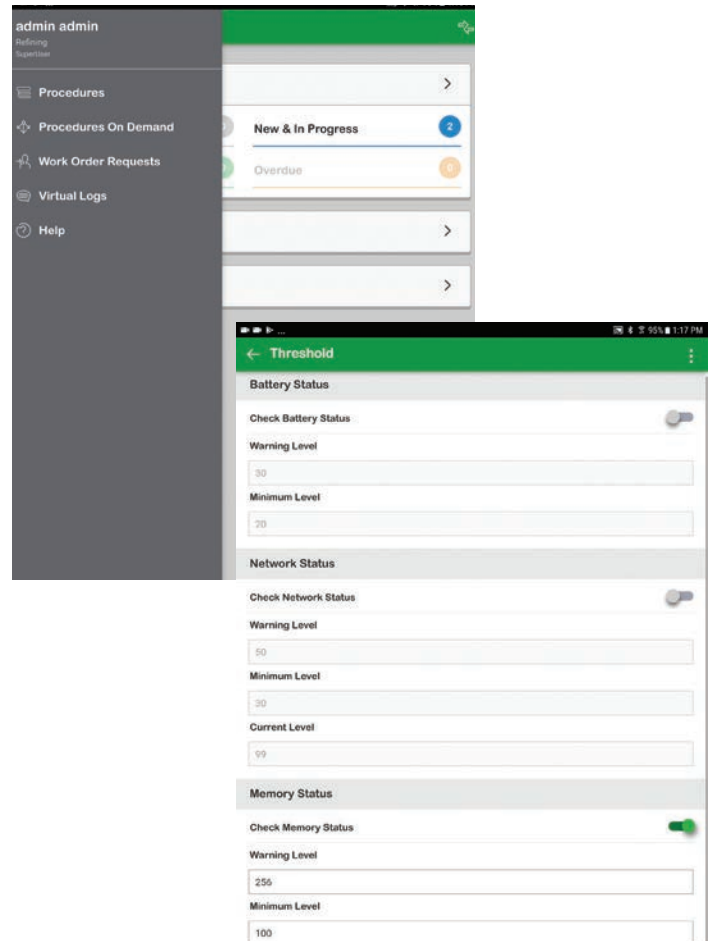



Improving the Efficiency of Your Maintenance Organization

Mobile Operator Rounds is a natural tool for improving the efficiency of maintenance activities. A complete list of daily maintenance tasks can be loaded in the software (including step-by-step instructions) so critical maintenance can be done right the first time.

If a wireless network is present, information on work order status, work requests, and current operating conditions can be made available to your field workers in real time. Maintenance workers will have the detailed information at their fingertips so they can get the job done in the shortest possible time.

Better Field Management of Capital Projects

Even with the best team, managing the installation and commissioning of new capital projects and turnarounds can be challenging. How do you know when specific field tasks have been accomplished? And if things change, and they always do, how do you ensure that everyone is on the same page?

Mobile Operator Rounds can provide the vital mobile infrastructure, including RFID location verification technology, that you can exploit to keep everyone informed and working the task list.

System Overview

As an enterprise level software and hardware solution Mobile Operator Rounds delivers a mobile workforce management solution to a wide range of industries. Languages supported include: English, Portuguese, Norwegian, Japanese, German.

Server Components/Integration Software

Database Server: Microsoft® SQL database server where system configuration, procedure content and collected data resides.

Synchronization Server: Microsoft Server for mobile device communication and Integrations. Mobile computers connect through the network, either by cradle, WiFi or Cellular to this server. Integrations to external systems are also typically hosted on this server.

Integration modules include Wonderware Galaxy, Wonderware Historian, OSIsoft® PI System, AspenTech® IP21, Honeywell® PHD and EAM integrations to Avantis®, SAP-PM and IBM Maximo® along with the Extensibility API components required for custom integrations.

Web Reports Server: Microsoft Server configured with IIS (Internet Information Services) hosting the Web Reports application.

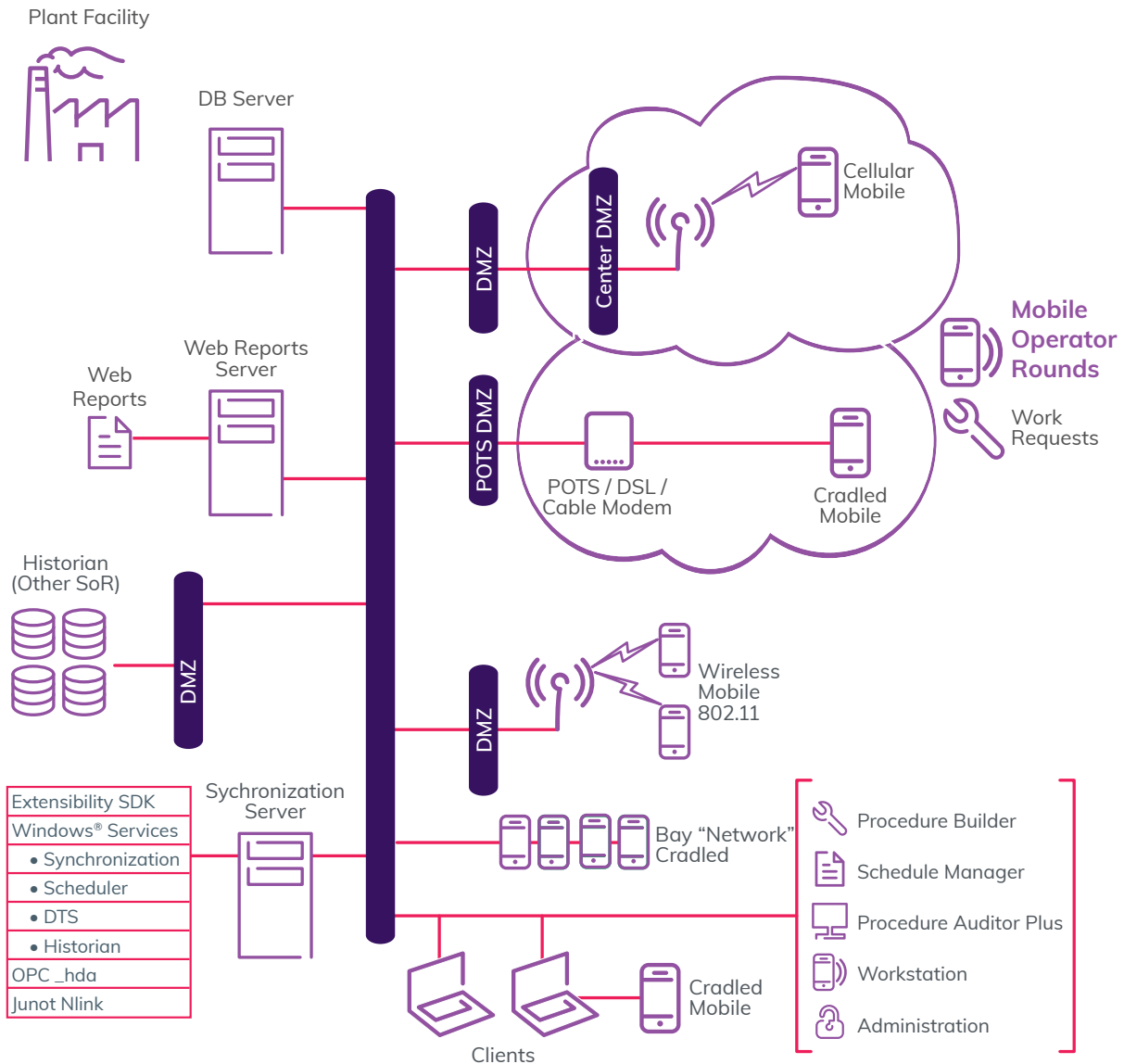

Desktop Clients

Management Center (MC): Hosts the individual application components used for content creation and management (Procedure Builder), scheduling (Schedule Manager), review & approval (Auditor Plus) as well as the Administration & Security application components. The Web Reports application is also accessed from the IMC.

Workstation: Desktop procedure execution interface similar to Mobile Operator Rounds.

Mobile Client

Mobile Operator Rounds: Windows Mobile client that provides a “best in class” browser style user interface for procedures and data collection tasks on specialized mobile devices.

Mobile Operator Rounds for Android: Includes a full featured modernized user interface for procedures and data collection tasks as well as visual feedback via context sensitive displays on tablet devices.

Mobile Operator Rounds for Windows 10: Windows 10 client that features a modernized user interface for procedures and data collection tasks as well as visual feedback via context sensitive displays on tablet devices.

Mobile Devices and Peripherals

Mobile Operator Rounds: Supports a broad selection of Windows Mobile based handheld computers from Motorola/Symbol, Bartec, and others. Supported peripherals include: RFID and barcode readers, vibration probes, temperature guns, and wireless communication devices.

Mobile Operator Rounds for Android: Supports commercially available Android phones and tablets as well as specialized rugged devices from Bartec, ECOM, Panasonic and others.

Mobile Operator Rounds for Windows 10: Supports commercially available Windows 10 PRO tablets such as the Windows Surface Pro, as well as specialized rugged devices from Bartec, ECOM, and others.

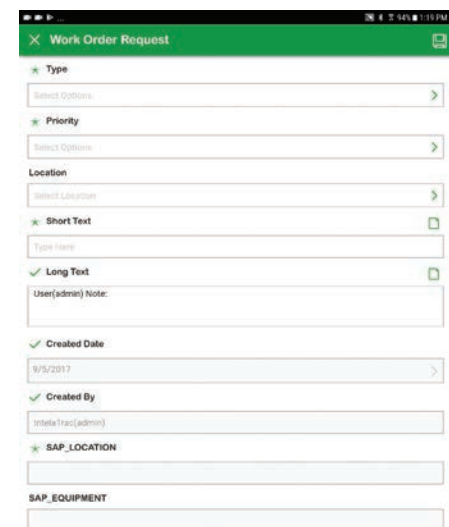
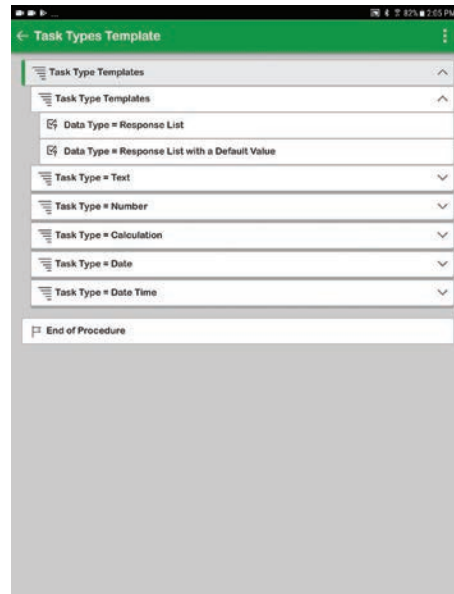
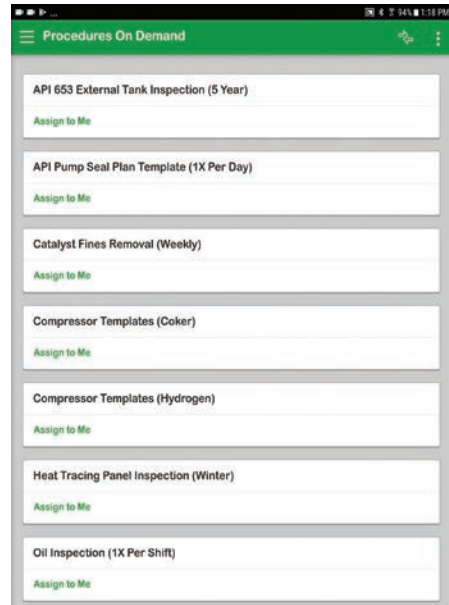



For more information on Mobile Operator Rounds, please contact your local distributor, or visit: sw.aveva.com/asset-performance/asset-maintenance/mobile-operator-rounds